

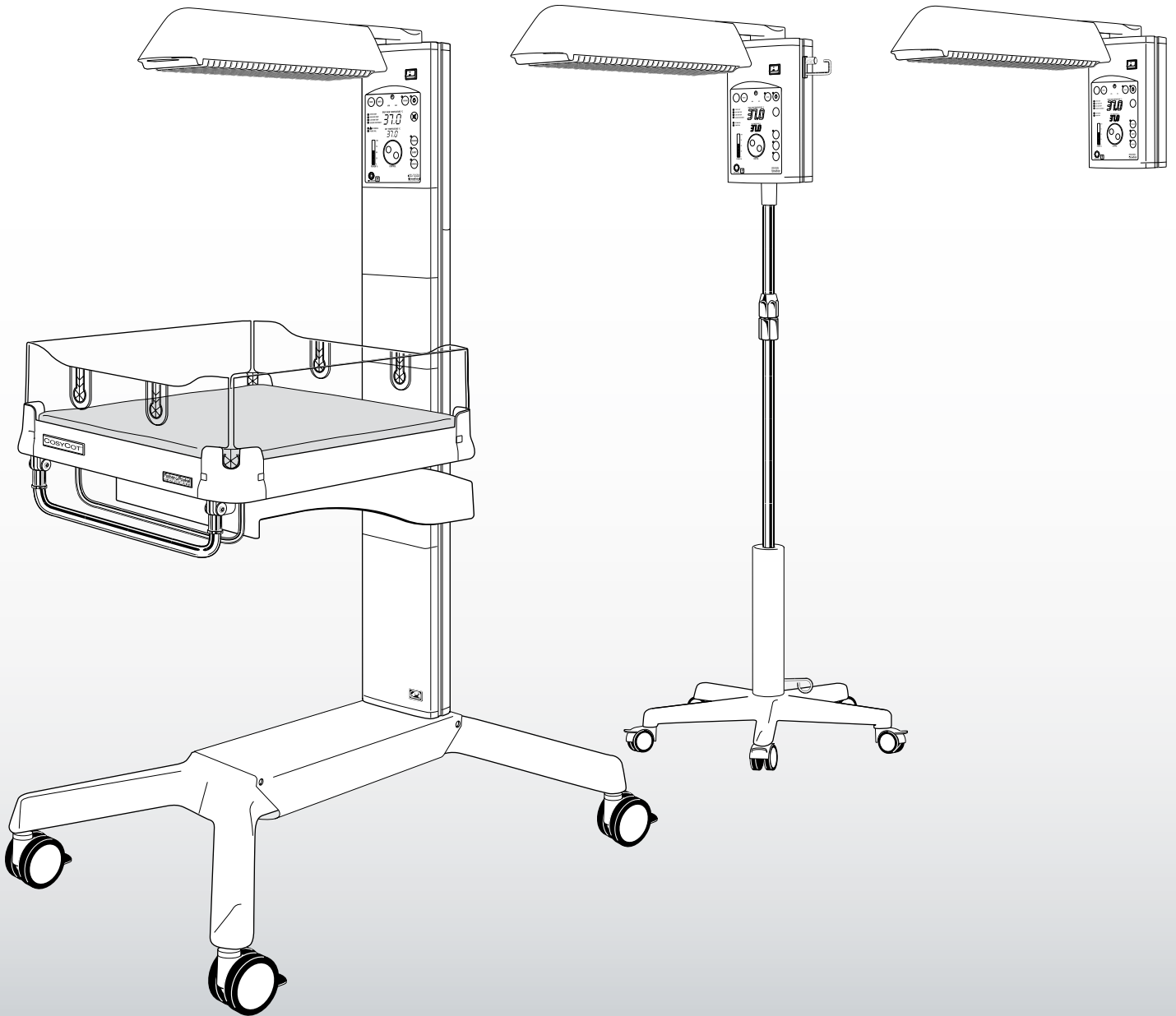

CosyCot™



900 Series Infant Warmer | Operating Manual



# TABLE OF CONTENTS

Contents	Page
<b>Chapter 1 - Read This First</b>	
Symbols.....	1-1
Definitions .....	1-2
Warnings - User and Patient Safety .....	1-2
Skin Sensor and Sensor Cover.....	1-3
Heater .....	1-3
Electrical .....	1-3
Bassinet .....	1-4
Elevator base models.....	1-4
Transport .....	1-4
Warmer Loadings.....	1-4
Oxygen Administration.....	1-5
Caution-Oxygen Administration.....	1-5
Phototherapy.....	1-5
Cleaning and Maintenance .....	1-5
Cautions - General.....	1-6
Alarm Summary - Baby Control Models .....	1-7
Manual control Models .....	1-8
Alarm Systems.....	1-8
Alarm Verification .....	1-8
Disabled Low Skin Temperature Alarm .....	1-8
Operator Position .....	1-8
Alarm Sound Level.....	1-8
<b>Chapter 2 - About Your Warmer</b>	
Application & Description.....	2-1
<b>Chapter 3 - Using Your Warmer</b>	
Warmer Diagrams.....	3-1
Controls & Indicators.....	3-2
Using Prewarm Mode .....	3-3
Placing the Skin Sensor.....	3-3
Using Baby Mode .....	3-5
Using Manual Mode .....	3-6
Using the Procedure Timers .....	3-6
Using the Apgar Timer .....	3-7
Using the Examination Light.....	3-7
Using the CosyCot™ Bassinet - IW930/950 Series.....	3-8
Raising and Lowering the Mobile Stand - IW910/920.....	3-10
Alarm Systems .....	3-10
Information Signals.....	3-13
Shut Down Procedure.....	3-13

# TABLE OF CONTENTS

## Chapter 4 - Accessories

Skin Sensors & Sensor Covers .....	4-1
Electric Elevator Module .....	4-1
Gas System Accessories .....	4-2
Flowmeter Modules .....	4-4
X-Ray Tray Module .....	4-4
Mounting Accessories .....	4-5
Storage Accessories .....	4-6
Uninterruptible Power Supply (UPS) .....	4-7
Phototherapy Accessories .....	4-8

## Chapter 5 - Cleaning & Maintenance

Cleaning.....	5-1
Maintenance .....	5-3

## Chapter 6 - Troubleshooting

General Assistance.....	6-1
-------------------------	-----





























## Chapter 7 - Appendices

Product Specifications.....	7-1
Standards and Approvals .....	7-5
Equipment Classifications .....	7-5
Environmental Specifications .....	7-5
General Information .....	7-5
Trademarks .....	7-6
Device and Consumable Disposal .....	7-6

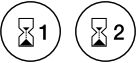
# Chapter 1 - Read This First

## 1. Symbols

**Before use** Please read and understand these symbols before using the warmer or accessories.

	Type B Equipment		High Temperature Alarm
	Type BF Applied Part		Low Temperature Alarm
	Caution: Electric Shock Hazards		WEEE Symbol (Waste Electrical and Electronic Equipment EU Directive)
	Alternating Current		Electrical Input
	Light		Gas Inlet
	Power On (connect to wall power supply)		Gas Outlet
	Power Off (disconnect from wall power supply)		Heater
	Power On (part of equipment)		Audio Pause (alarm silence)
	Power Off (part of equipment)		Portable and mobile RF communications equipment can effect MEDICAL ELECTRICAL EQUIPMENT
	Sensor Disconnect		Follow Instructions For Use - Safety
	Power Disconnect		Consult Instructions for Use
	Procedure Timer 1 & 2		
	APGAR		
	Temperature Sensor		
	25% Power Level (Prewarm or Standby mode)		
	Baby Mode (Servo mode)		
	Manual Mode		
	Check Baby		

## 2. Definitions

**Before use** Please read and understand these definitions before using the warmer or accessories.

### Warning statement

#### **WARNING**

- A **WARNING** statement refers to the conditions when the possibility of injury to the patient or user exists if a procedure is not followed correctly.

### Caution statement

#### CAUTION

- A Caution statement indicates the possibility of damage to the equipment exists if a procedure is not followed correctly.

### Note statement

#### *NOTE:*

- A Note statement provides additional information intended to clarify points, procedures or instructions.

## 3. User & Patient Safety

**Before use** Please read and understand these definitions before using the warmer or accessories.

### **WARNINGS**

- This product is intended for use by authorised and qualified medical personnel who are aware of currently known hazards and benefits of infant radiant warmers.
- All personnel must be familiar with the operation of this warmer before using the device with patients.
- Do not use in the presence of a flammable anaesthetic mixture with oxygen or nitrous oxide, or other flammable materials.
- Overloading the shelves and mounting brackets may affect the stability of the warmer.
- Independent monitoring of temperature is essential for any baby under an infant radiant warmer.
- A warmer cannot differentiate between hypothermia (low skin and low core temperature), and fever (low skin and high core temperature). Ensure the clinical condition of the baby is regularly reviewed.
- When using the warmer in Manual mode, continuously monitor the baby's clinical condition and temperature.
- It is inadvisable to leave a baby unattended under an infant radiant warmer.
- The heat emitted by a radiant warmer may increase the baby's insensible water loss. Consider appropriate measures to maintain proper fluid balance.
- Do not use the warmer if the See Manual alarm is activated. Remove the unit from service and refer to qualified personnel.
- Ensure that all limbs are clear of moving parts under the base and legs while operating the base.
- Unlock the front wheels before raising or lowering the base.
- Be careful not to dislodge feeding tubes and respiratory lines when operating the electric elevator base.
- Cobedding is not advisable on the CosyCot. If cobedding is necessary continuously monitor the babies clinical condition and temperature.

# Chapter 1 - Read This First

## 4. Skin Sensor & Sensor Cover

### **WARNINGS**

- The warmer cannot measure or control the baby's skin temperature if the skin sensor is not correctly positioned on the baby or a reflective sensor cover is not used.
- Use only the 900IW001 DuoSense™ or the NC-02X SureSense™ skin sensors to measure the baby's skin temperature.
- Regularly check that the skin sensor and sensor cover remain correctly positioned on the baby.
- Ensure the skin sensor is always in direct contact with the baby's skin.
- Never place an obstruction between the heater and the skin sensor other than a reflective sensor cover.
- Heating is obstructed if the baby is wrapped in a blanket which comes between the heater and the skin sensor.
- Do not use an axillary or rectal temperature sensor measurement to control baby skin temperature. Use of an axillary or rectal temperature sensor measurement to control baby skin temperature can result in over-heating or under-heating of the baby.
- While in Manual mode, the displayed skin temperature is for monitoring purposes only and not used to control heater power.

## 5. Heater

### **WARNINGS**

- The warmer does not adjust for patient temperature in PreWarm Mode. PreWarm Mode delivers less than 10 mW/cm<sup>2</sup> irradiance across the mattress.
- Ensure there is at least 30 cm (12") clear airspace above the Heater.
- **Mobiles and Wallmounts** – For optimal warming ensure the heater grill to mattress distance is 68 cm (27"). Less than 65 cm (25.5") or more than 80 cm (31.5") may affect warmer performance, may result in over-heating or under-heating of the baby, and may affect the baby's clinical condition.
- Do not place anything between the heater and patient that may prevent radiant heat from being effective.
- Ensure the heater head is directly over the patient or in a central position on the CosyCot™.
- A baby's thermal balance can be affected by ambient conditions. Do not place an infant radiant warmer in direct sunlight, near another heat source, or in draughty conditions.
- Accessories such as phototherapy lamps and heated mattresses can affect warmer performance by altering the heat distribution across the bassinet mattress.
- Never place objects on top of the warmer heater. Never attach objects to any surface on the warmer heater.

## 6. Electrical

### **WARNINGS**

- To avoid risk of electric shock, this equipment must only be connected to a supply mains with protective earth.
- Ensure additional equipment connected to the baby or the warmer is electrically safe.
- Ensure the power supply is continuous, earthed, approved for hospital use and complies with the voltage specified on the unit.
- Ensure a power regulator is used if the power supply voltage or frequency is likely to vary outside the specified range.
- Electrical shock hazards exist beneath the control panels. Ensure all service and maintenance is carried out by qualified personnel.
- Do not use an additional multiple socket-outlet or extension cords to connect the warmer to the power supply. Use only hospital grade power cords and plugs.
- User must regard EMC, please install and put in service IW900 series warmers according to the EMC information provided in the accompanying Product Technical Manual 185048310.
- Portable and mobile RF communications equipment can affect medical electrical equipment.
- Ensure the warmer does not block access to the power supply outlet.
- Only electrical items specified by Fisher & Paykel Healthcare shall be connected to the warmer.

## 7. Bassinet

### **WARNINGS**

- Ensure the bassinet is level and side panels are locked into position before transport. Use the transport handle and ensure drawers are in the central position.
- Do not move the warmer by pushing or pulling on the bassinet side panels. This action may lead to the deterioration and breakage of the components that act as a safety barrier around the baby.
- Tilting the bassinet from the horizontal position can affect warmer performance by altering the heat distribution across the bassinet mattress.
- Inspect all tubes or wires connected to the baby before and after tilting bassinet. Tilting or moving the warmer bassinet can pull on tubing or leads.
- Do not use the bassinet without the Fisher & Paykel Healthcare mattress.
- Ensure the patient and operator limbs are clear of bassinet side panels when opening and closing.
- Do not leave the baby unattended in the bassinet when the side panels are folded down.
- Do not lean on the bassinet.
- Take care not to dislodge tubes and lines when opening or closing side panels.
- Regularly check side panels are securely locked in the vertical position.

## 8. Elevator Base Models

### **WARNINGS**

- Ensure that all limbs are clear of moving parts under the base and legs while operating the electric elevator base.
- Unlock the front wheels before raising or lowering the bassinet.
- Be careful not to dislodge feeding tubes and respiratory lines when operating the electric elevator base.
- Ensure Bassinet Side Panels are raised when operating the electric elevator module.

## 9. Transport

### **WARNINGS**

- Ensure all wheels are unlocked before using the CosyCot™ or Mobile for transport.
- Always hold on to the infant warmer when transporting.
- Use the transport handle in a horizontal position when transporting to avoid moving the bassinet.
- Always lock the wheels before use.
- Ensure the mobile stand is adjusted to the lowest position before transport.

## 10. Warmer Loadings

### **WARNINGS**

- Care should be taken to ensure that the maximum total accessory weight on the warmer does not exceed the maximum specified. Refer to the “Specification for IW93x and IW95x CosyCot™ Infant Warmer” located at the back of this operating manual.
- Maximum bassinet loading is 10 kg (22 lb).
- Do not exceed maximum side load limits specified on the column label.
- Maximum side loads for the CosyCot™ infant warmer are:  
15 kg (33 lb) below label  
5 kg (11 lb) above label
- Ensure all mounting accessories are securely fastened in the column mounting slot before items are placed or attached to each accessory.
- Do not exceed the maximum total storage drawer and storage tray loading of 7 kg (15.4 lb).
- 900IW313 IV Pole Quad Hook is not suitable for use with IW910/920 Mobile Warmers.



# Chapter 1 - Read This First

## 11. Oxygen Administration

### **WARNINGS**

- Care should be taken to ensure that the maximum total accessory weight including gas cylinders on the warmer does not exceed the maximum specified. Refer to the “Specification for IW93x and IW95x CosyCot™ Infant Warmer” located at the back of this operating manual.
- The attending physician should prescribe the method, concentration and duration of oxygen administration.
- Improper use of oxygen may be associated with serious side effects, including blindness, brain damage and death.
- Oxygen-enriched gas has been found to increase the risk of retinopathy of prematurity. Use arterial blood gas measurement for regulation of inspired oxygen concentration when oxygen-enriched gas is necessary.
- Keep ignition sources away from the warmer and out of the room in which oxygen equipment is located.
- Ensure no foreign material is present in the flowmeter nipples or patient supply lines.
- Always adjust the flowmeter valves slowly to avoid excessive pressure in patient supply lines.
- To avoid possible patient injury or flowmeter damage do not attempt to adjust the flowmeter flowrate above 15 L/min.
- Ensure the cylinder valves are closed when the hospital pipeline systems are in use. Supply pressures may become equal and if used simultaneously, cylinder supplies could be exhausted leaving no emergency backup supply.
- Compressed gas cylinders can become hazardous projectiles if the gas is released rapidly. To prevent damage from shock or impact, the cylinders must be securely fastened.
- Never use grease, oil, organic lubricants or flammable materials with high oxygen concentrations.
- Use an oxygen monitor when oxygen is administered.

### **CAUTION**

- Disconnect and turn off the oxygen supply when cleaning the unit or performing service and maintenance procedures.
- Ensure cylinder valves are opened slowly to avoid damage to the regulators and resuscitation system.
- Ensure only one cylinder gasket is used per yoke. Using more than one gasket could result in gas leakage.

## 12. Phototherapy

### **WARNINGS**

- This product is intended for use by authorized and qualified personnel who are aware of currently known hazards and benefits of phototherapy for treatment of hyperbilirubinemia.
- All personnel must be familiar with the operation of this phototherapy system before using the device with patients.
- Protect baby’s eyes and genitals from Phototherapy light.
- Do not look directly at the blue light.
- Ensure Phototherapy Lamp head is securely fitted to the mounting bracket.
- Electric shock hazards exist beneath the control panels. Ensure qualified personnel carry out all service and maintenance issues.

## 13. Cleaning & Maintenance

### **WARNINGS**

- Only qualified personnel should carry out service and maintenance procedures.
- To avoid the possibility of burns when performing cleaning and maintenance procedures, ensure the warmer is disconnected from the power supply by removing the plug from the mains outlet and the heater element is allowed to cool.
- To avoid the possibility of electric shock hazard when performing cleaning and maintenance procedures, ensure the warmer is disconnected from the power supply by removing the plug from the mains outlet.
- Ensure all oxygen and air supplies are turned off and disconnected from the warmer before performing cleaning and maintenance procedures.
- Explosion and fire hazards can exist when performing cleaning and maintenance procedures in an oxygen-enriched environment.



## 14. General

**Before use** Please read and understand these definitions before using the warmer or accessories.

### **WARNING**

- **No modification of this equipment allowed.**

### CAUTION





- US Federal law restricts this device to sale by or on the order of a physician.
- Do not stand on any part of the warmer base.
- Do not autoclave or gas sterilise the 900IW001 DuoSense™ or the NC02X SureSense™ skin sensors.
- Do not autoclave or gas sterilise any part of the warmer.
- Ensure the skin sensor is only removed from the controller by grasping the plug at the front panel. Ensure excessive strain is not placed on the sensor lead during use, cleaning or inspection.
- Do not remove the skin sensor from the baby's skin by placing excessive strain on the cable. Such a procedure can damage the skin sensor and cause irritation to the baby.
- Ensure the bassinet side panels are not used to move the warmer.
- Do not use alcohol, solvents, or abrasive cleaning solutions for cleaning surfaces of the warmer. The use of alcohol and other solvents for cleaning acrylic surfaces can cause crazing and cracking.
- Do not expose plastic and acrylic surfaces to direct radiation from germicidal lamps. The ultraviolet radiation from these sources can cause crazing and cracking.
- Ensure all warmer parts and accessories are checked before returning the device to service. Refer to relevant sections of this operating manual for directions.
- For cold sterilisation: Ensure the cold sterilisation agents are safe for use with the relevant warmer surfaces. If in doubt check with supplier of these agents.
- For chemical liquid immersion: Some chemicals can be harmful to plastics. If in doubt check with chemical supplier.

# Chapter 1 - Read This First

## 15. Alarm Summary, Baby Control Models IW910/930/980

### Before use

Please read and understand the following alarm summary for baby control models before using the warmer or accessories.



Alarm	Mode	Cause	Effect	Audio Pause Button
Check Baby 	Baby	Warmer operating at 100% power for longer than 15 minutes	Heater reduced to 25% power	Cancels alarm & restores heater power
	Manual	Warmer operating at more than 25% power for longer than 15 minutes	Heater reduced to 25% power	Cancels alarm & restores heater power
	Prewarm	Not active	Not active	Not active
High Skin Temp +1°C	Baby	Measured skin temperature higher than set temperature by 1°C	Heater power disabled	Silences audible alarm only
	Manual	Measured skin temperature higher than 39°C	Heater power disabled	Silences audible alarm only
	Prewarm	Measured skin temperature higher than 39°C	Heater power disabled	Silences audible alarm only
Low Skin Temp -1°C	Baby	Measured skin temperature lower than set temperature by 1°C	Heater reduced to 25% power	Silences audible alarm & restores heater power
	Manual	Not active	Not active	Not active
	Prewarm	Not active	Not active	Not active
Sensor Disconnect 	Baby	Skin sensor unplugged or faulty	Heater power disabled	Silences audible alarm only
	Manual	Skin sensor faulty	Heater power disabled	Silences audible alarm only
	Prewarm	Not active	Not active	Not active
See Manual 	All	Software or electronic fault detected	Warmer disabled	No effect
Power Fail 	All	Power supply to warmer failed	Warmer disabled	No effect

# Chapter 1 - Read This First

## 16. Alarm Summary, Manual Control Models IW920/950/990

### Before use

Please read and understand the following alarm summary for baby control models before using the warmer or accessories.

Alarm	Mode	Cause	Effect	Manual Button
Check Baby 	Manual	Warmer operating at more than 25% power for longer than 15 minutes	Heater reduced to 25% power	Cancels alarm & restores heater power
		OR measured skin temperature higher than 39°C	Heater power disabled	No effect
		OR skin sensor faulty	Heater power disabled	No effect
	Prewarm	Measured skin temperature higher than 39°C	Heater power disabled	No effect
See Manual 	All	Software or electronic fault detected	Warmer disabled	No effect
Power Fail 	All	Power supply to warmer failed	Warmer disabled	No effect

## 17. Alarm Systems

### WARNING

- See Alarm Systems on page 3-10 for full details of alarm systems, possible causes and recommended action.
- Only the alarm condition active at the time of pushing the Audio Pause Button will be affected. Muting will continue until either the alarm condition is rectified or another alarm condition is activated.

## 18. Alarm Verification

### NOTE:

- See page 3-12 for procedures to verify operation of alarms.
- All alarms are indicated by a flashing yellow light and audible alarm, except for See Manual which may use a flashing or continuous light.

## 19. Disabled Low Skin Temperature Alarm

### NOTE:

- If the baby's skin temperature is less than the set temperature when Baby mode is first selected, the Low Skin Temperature alarm is disabled for 15 minutes or until the baby skin temperature has warmed up to the set temperature.
- The 15 minute warm-up period enables safe continuous warming of the baby without nuisance alarms.

## 20. Operator Position

The Operator Position is defined as being midway on either side of the CosyCot™ bassinet or, for Mobile and Wallmount Warmers, at a distance less than 600 mm from the front control panel.

## 21. Alarm Sound Level

3m from front of the Infant Radiant Warmer >65 dBA  
 At the mattress <80 dBA

# Chapter 2 - About Your Warmer

## 1. Application and Description

- (a) **Introduction**
- i The Fisher & Paykel infant radiant warmers are specifically designed to provide a controlled source of warmth to babies in the first few weeks of life. The warmers can provide complete care for the newborn baby in delivery through to the critically ill baby in neonatal intensive care.
- (b) **Models**
- i The CosyCot™ Infant Warmer combines an integrated bassinet with optional accessories to suit your own particular warming needs.
  - ii The Mobile Infant Warmer provides truly mobile warming wherever needed.
  - iii The Wall Mount Infant Warmer provides discrete and convenient space saving warming.
  - iv 

<b>Model</b>	<b>Baby Control</b>	<b>Manual Control</b>
Mobile	IW910	IW920
CosyCot™	IW930 (Series)	IW950 (Series)
Wall Mount	IW980	IW990
- (c) **Heat control**
- i In Baby mode, the baby control models provide stable control of the baby's skin temperature by automatically adjusting the heater power to compensate for varying physiological and environmental conditions. This is achieved using a microprocessor which measures and updates the baby's temperature ten times every second.
  - ii In Manual mode, all warmers provide user-adjustable heater power and the option to monitor the baby's skin temperature using the skin sensor.
  - iii In Prewarm mode, all warmers provide general alarm free prewarming of the heater and environment above the warmer mattress.
- (d) **Skin sensor temperature measurement**
- i The 900IW001 Duosense™ skin sensor measures the baby's skin temperature using two independent sensors. These sensors are continuously compared to ensure accurate and reliable skin temperature measurements. The 900IW001 Duosense™ should be used in conjunction with NC04x DaisyDot™ sensor covers for accurate temperature measurement.
  - ii Single Patient Use Temperature Sensor. The SureSense™ temperature sensor can be used in conjunction with the DaisyDot™ sensor covers.  
The Single Patient Use temperature sensor require a re-usable leash adaptor 900IW003 for operation.
- (e) **Operating manual**
- i This operating manual must be read thoroughly and all instructions, warnings, cautions and notes thoroughly understood by personnel working with the warmers and accessories.

# Chapter 3 - Using Your Warmer

## 1. Warmer Diagrams

**IW910/920 Mobile Infant Warmer**

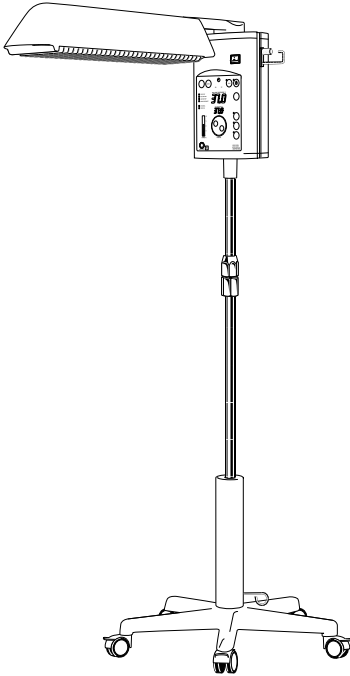

**IW930/IW950 Series CosyCot™**

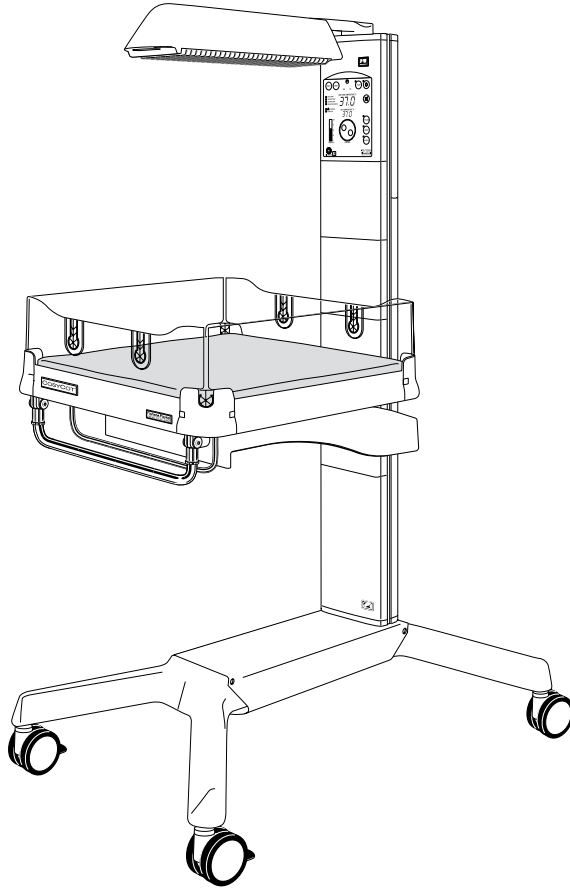

**IW980/990 Wall Mount Infant Warmer**

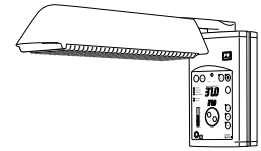

**Baby Controlled Front Control Panel  
IW910, IW930 Series and IW980**

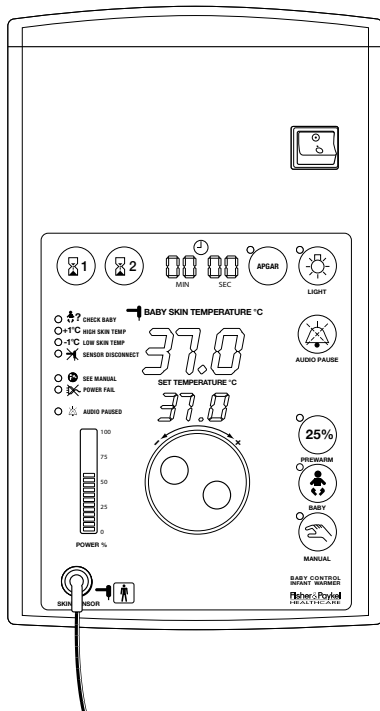

**Manual Controlled Front Control Panel  
IW920, IW950 Series and IW990**

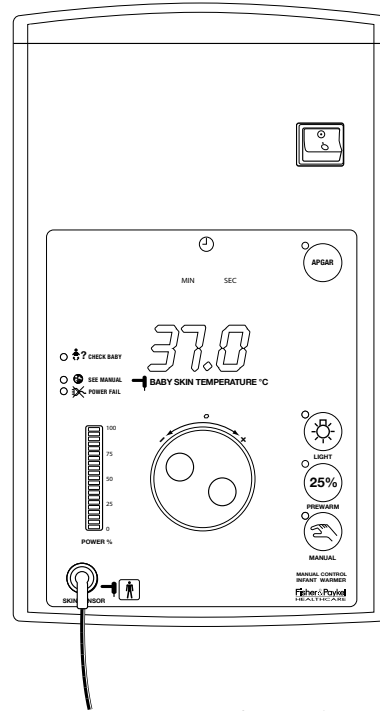

# Chapter 3 - Using Your Warmer

## 2. Controls & Indicators

### Before use

While reading this section you may find it helpful to look at the diagrams on page 3-1.

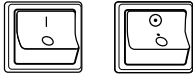

### Power Switch

The warmer starts up automatically in the last mode that was used.

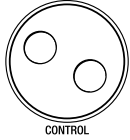

### Control Knob

Adjusts set temperature in Baby mode and power level in Manual mode. Adjusts preset countdown time when either the Timer 1 or Timer 2 buttons are held down (Baby control models only).

BABY SKIN TEMPERATURE °C

37.0

### Baby Skin Temperature Display

Displays the current baby skin temperature when a skin sensor is inserted in Baby mode or Manual mode and the skin sensor is correctly attached to the baby. In Baby mode displays '---' in the event of a Sensor Disconnect alarm. The display switches off when in Prewarm mode or when no skin sensor is inserted in Manual mode.

SET TEMPERATURE °C

37.0

### Set Temperature Display (Baby control models only)

Displays the current set temperature when in Baby mode. The display switches off in Prewarm mode or Manual mode. The set temperature range is from 34.5 °C to 37.5 °C.

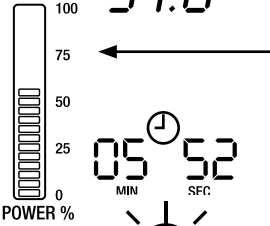

### Power Display

Displays the current power level in the range 0% to 100% in 5% steps.

05 52  
MIN SEC

### Timer Display (Baby control models only)

Displays the current time of the Apgar timer, Timer 1 or Timer 2 when they are active.



### Audio Pause (Baby control models only)

Pressing this button silences all audible alarms (except See Manual and Power Fail) and illuminates the green Audio Pause mode indicator for 10 minutes. The Check Baby alarm is reset for 15 minutes



### Prewarm

Pressing this button selects Prewarm mode and illuminates the green Prewarm mode indicator light. The Power level is preset to 25% to provide alarm and trouble free prewarming of the heater and environment above the warmer mattress before arrival of the baby.

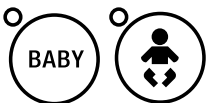

### Baby (Baby control models only)

Pressing this button selects Baby mode and illuminates the green Baby mode indicator light. The Power level is automatically controlled according to the baby skin temperature to achieve the desired set temperature.



### Manual

Pressing this button selects Manual mode and illuminates the green Manual mode indicator light. The Power level is adjustable using the Control knob in the range 0% to 100% in 5% steps.



### Apgar

Pressing this button starts the Apgar timer and illuminates the green Apgar indicator light. Apgar tones sound at 1, 5 and 10 minutes. The Apgar timer switches off after 60 minutes. Pressing the button a second time will cancel and switch off the Apgar timer.



### Examination Light

Pressing this button switches the Examination Light on and off. The green Light indicator is illuminated when the light is on. If the light is faulty, the warmer will sound a tone and the light indicator will be switched off



### Procedure Timer 1 & 2 (Baby control models only)

Pressing this button starts Timer 1 & 2 at the preset count-down time. Pressing the button a second time will cancel and switch off the timer. Holding the button down allows the Timer count-down time to be adjusted with the control knob.

## 3. Using Prewarm Mode

### (a) About Prewarm Mode

- i Prewarm mode provides alarm and trouble free prewarming of the heater and environment above the warmer mattress before arrival of the baby.
- ii Prewarm mode should be selected at least 5 minutes before the baby is placed on the warmer. Prewarm mode may also be used to provide low power background heating when required.
- iii The Infant Radiant Warmer does not adjust for Patient Temperature in PreWarm Mode. When a baby is placed under the warmer, either the Manual or Baby power modes should be selected immediately.

### (b) How to use Prewarm Mode

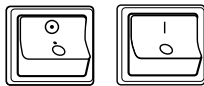

- i Press the Power On/Off switch to the On position. The warmer starts up automatically in the mode that was last used.
- ii Select Prewarm mode by pressing the Prewarm button. The Power level is preset to 25%.
- iii The warmer will now operate continuously at the preset power level without any nuisance alarms (except if temperature sensor > 39°C).

### (c) Prewarm

#### **WARNINGS**

- Prewarm mode maintains the total infrared irradiance level at the mattress surface below 10 mW/cm<sup>2</sup>, as prescribed in IEC 60601-2-21, "Particular requirements for the safety of infant radiant warmers".
- The Infant Radiant Warmer does not adjust for Patient Temperature in PreWarm Mode.

## 4. Placing the Skin Sensor

### (a) How to place the skin sensor



- i Gently clean and dry the baby's skin where you intend to place the skin sensor.
- ii Remove the backing paper from the sensor cover.
- iii Place the coloured side of the skin sensor in the centre of the adhesive side of the sensor cover as shown.
- iv Place the skin sensor and sensor cover against the baby's skin in the desired location.
- v Gently press and hold the edges of the sensor cover to allow the hydrogel adhesive to adhere to the baby's skin.

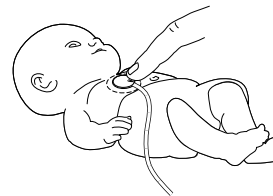

## Chapter 3 - Using Your Warmer

### (b) How to remove and resite the skin sensor

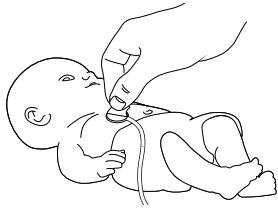

- i Gently lift up the edge of the sensor cover. If required moisten the edges of the sensor cover using a cotton swab dampened with sterile water
- ii Gently peel the sensor cover and skin sensor from the skin surface. Take care not to pull directly on the skin sensor wire.
- iii Reposition the sensor cover and skin sensor on the baby.
- iv Gently press and hold the edges of the sensor cover to allow the hydrogel adhesive to adhere to the baby's skin.

### (c) Clinical procedures

#### *NOTE:*

- To ensure the continued comfort of the baby, avoid pressing directly on the skin sensor.

### (d) Skin sensor & sensor cover

#### **WARNINGS**

- **The warmer cannot measure or control the baby's skin temperature if the skin sensor is not correctly positioned on the baby or a reflective sensor cover is not used.**
- **Use only the 900IW001 DuoSense™ or the NC02x SureSense™ skin sensors to measure the baby's skin temperature.**
- **Regularly check that the skin sensor and sensor cover remain correctly positioned on the baby.**
- **Ensure that the skin sensor is always in direct contact with the baby's skin.**
- **Never place an obstruction between the heater and the skin sensor other than a reflective sensor cover.**
- **Heating is obstructed if the baby is wrapped in a blanket which comes between the heater and the skin sensor.**
- **Do not use an axillary or rectal temperature sensor measurement to control baby skin temperature. Use of an axillary or rectal temperature sensor measurement to control baby skin temperature can result in over-heating or under-heating of the baby.**

### (e) 900IW001 DuoSense™ skin sensor

#### CAUTION

- Ensure the skin sensor is only removed from the controller by grasping the plug at the front panel. Ensure excessive strain is not placed on the sensor lead either during use, cleaning or inspection.

### (f) NC02x SureSense™ temperature sensors

#### CAUTION

- The single patient use temperature sensors are interfaced to the warmer via a Reusable Adaptor 900IW003. Take care not to put excessive strain on the leash.



## 5. Using Baby Mode

### (a) About Baby mode

- i Baby mode provides stable control of the baby's skin temperature by automatically adjusting the heater power to compensate for varying metabolic and environmental conditions. By measuring and updating the baby's temperature ten times per second, Baby Mode provides optimal thermoregulation and is recommended as the preferred mode of maintaining the patient's body temperature.

### (b) Before you begin

- i See Using Prewarm Mode on page 3-3, Placing the Skin Sensor on page 3-3, and Alarm System Verification on page 3-12.

### (c) How to use Baby mode

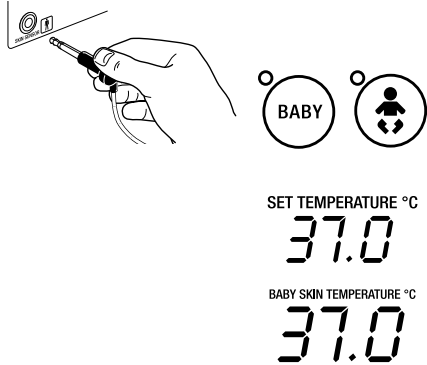

- i Push the skin sensor plug firmly into the front panel socket or plug the electrical connector of the single patient use temperature sensors into the reusable adaptor 900IW003. Push adapter firmly into socket.
- ii When the baby arrives, place on the warmer mattress and correctly attach the skin sensor.
- iii Select Baby mode by pressing the Baby button.
- iv Set the desired skin temperature between 34.5°C and 37.5°C by turning the control knob on the front panel. The set temperature is displayed above the control knob.
- v With the skin sensor plug correctly inserted into the front panel socket and the skin sensor correctly positioned on the baby, the baby's skin temperature is displayed above the control knob.

The warmer will now automatically adjust the heater power to stabilise the baby's skin temperature at the desired set temperature.

### (d) Clinical condition

#### **WARNINGS**

- **Independent monitoring of temperature is essential for any baby under an infant radiant warmer.**
- **A warmer cannot differentiate between hypothermia (low skin and low core temperature), and fever (low skin and high core temperature). Ensure the clinical condition of the baby is regularly reviewed.**

### (e) Disabled low skin temperature alarm

#### *NOTE:*

- If the baby's skin temperature is less than the set temperature when Baby mode is first selected, the Low Skin Temperature alarm is disabled for 15 minutes or until the baby's skin temperature has warmed up to the set temperature.
- The 15 minute warm-up period enables safe continuous warming of the baby without nuisance alarms.

### (f) Warm-up time

#### *NOTE:*

- The baby's weight, age, clinical condition, and other metabolic and environmental factors, will affect the time required to stabilise at the desired set temperature.

### (g) Temperature adjustments

#### *NOTE:*

- Allow 5 to 10 minutes for the baby's skin temperature to stabilise after set temperature adjustments

# Chapter 3 - Using Your Warmer

## 6. Using Manual Mode

(a) **About Manual mode**

Manual mode provides user-adjustable heater power, and the option to monitor the baby's skin temperature using the DuoSense™ skin sensor or an independent temperature monitor.

(b) **Before you begin**

See Using Prewarm Mode on page 3-3, and Alarm System Verification on page 3-12. If monitoring baby's skin temperature see Placing the Skin Sensor on page 3-3.

(c) **How to use Manual mode**

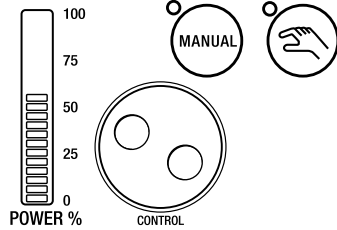

i Select Manual mode by pressing the Manual button.

ii Set the desired heater power level between 0% and 100% by turning the control knob on the front panel. The heater power level is displayed on the power bar to the left of the control knob.

The baby can now be placed on the warmer mattress, and the warmer will deliver the set heater power.

iii When using Manual mode the baby's skin temperature should be monitored using a skin sensor or an independent temperature monitor.

iv If monitoring is required, place the skin sensor on the baby, and push the skin sensor plug firmly into the front panel socket or plug the electrical connector of the single patient use temperature sensors into the re-usable adaptor 900IW003. Push adaptor firmly into socket.



v With the skin sensor plug correctly inserted into the front panel socket and the skin sensor correctly positioned on the baby, the baby's skin temperature is displayed above the control knob.

(d) **Independent monitoring**

**WARNINGS**

- **Independent monitoring of temperature is essential for any baby under an infant radiant warmer.**
- **When using the warmer in Manual mode continuously monitor the baby's clinical condition and skin temperature using a skin sensor or an independent temperature monitor.**
- **While in Manual mode, the displayed skin temperature is not used to control heater power.**

(e) **15 minute Manual mode alarm**

*NOTE:*

- If the heater power level is above 25% for longer than 15 minutes, the Check Baby and Manual indicators will flash, an audible alarm will sound, and the heater power will be reduced to 25%.
- If the Manual or Audio Pause button is now pressed, the Check Baby and Manual indicators will be extinguished, the audible alarm silenced and the heater power will be restored at the set level.

## 7. Using the Procedure Timers (Baby Control Models Only)

(a) **About the procedure timers**

i The two timers provide simple count-down timing of clinical procedures, each sounding a tone at the completion of their preset time period. Both timers can be independently preset from 1 to 99 minutes.

# Chapter 3 - Using Your Warmer

## (b) How to set the procedure timers

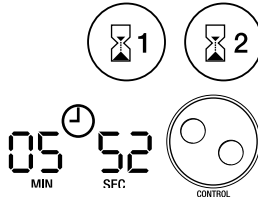

- i Press and hold down either Timer 1 or Timer 2 button.
- ii Set the desired count-down time for the chosen procedure timer by turning the control knob on the front panel. The count-down time is shown on the timer display.
- iii Release the procedure timer button to start the count-down.
- iv Press the procedure timer button again if you wish to cancel the timer.

## (c) Timer memories

*NOTE:*

- Each procedure timer will remember its own count-down time until reset with a new count-down time period.
- Only one procedure timer can be active at any time.

## (d) How to use the procedure timers



- i Press the desired timer button to start the count-down period.
- ii Press the same timer button again if you wish to cancel the timer.

## (e) Timer completion

*NOTE:*

- At the end of the time period the procedure timer will produce tones, flash the timer display for 30 seconds then switch off the display.

## 8. Using the Apgar Timer

### (a) About the Apgar timer

- i The Apgar timer provides easy timing of Apgar scores. Apgar tones sound at 1, 5 and 10 minutes. The Apgar timer switches off after 60 minutes.

### (b) How to use the Apgar timer



- i Press the Apgar button to start the Apgar timer.
- ii Press the Apgar button again if you wish to cancel the Apgar timer.

## 9. Using the Examination Light

### (a) How to use the light

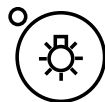

- i Press the Light button to switch on the light.
- ii Press the Light button again to switch off the light.

### (b) Light faulty

*NOTE:*

- If the light is faulty or fails during use, the warmer will sound a tone and the Light indicator will be switched off. Please refer to the IW900 Series Infant Warmer Technical Manual for servicing information (pn 185048310).

# Chapter 3 - Using Your Warmer

## 10. Using the CosyCot™ Bassinet - IW930/950 Series

- (a) **About the bassinet**
  - i The bassinet provides a support platform for the mattress, which in turn provides a comfortable and thermally insulated surface for nursing and caring for the baby. The bassinet can be continuously adjusted from  $-10^{\circ}$  to  $+10^{\circ}$ , to achieve Trendelenburg and Fowler type positions.
  
- (b) **How to tilt the bassinet**
  - i Grip the lever beneath the front of the bassinet with both hands and squeeze together to unlock the bassinet tilt mechanism.
  - ii Tilt the bassinet to desired position from  $-10^{\circ}$  to  $+10^{\circ}$ .
  - iii Release lever to lock the bassinet in new position.
  - iv Horizontal position is found by unlocking tilt mechanism and adjusting tilt until central detente is felt.

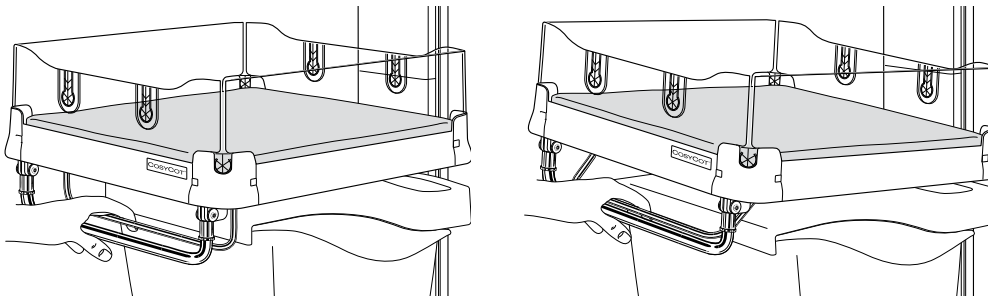

- (c) **How to transport the bassinet**
  - i Ensure the bassinet side panels are locked into position before transporting.
  - ii Check the castor wheels are not locked.
  - iii Locate the transport handle beneath the front of the bassinet
  - iv Pull down the spring loaded collars at the sides of the handle and re-orient the transport handle to the horizontal and release the collars to lock the handle into position.

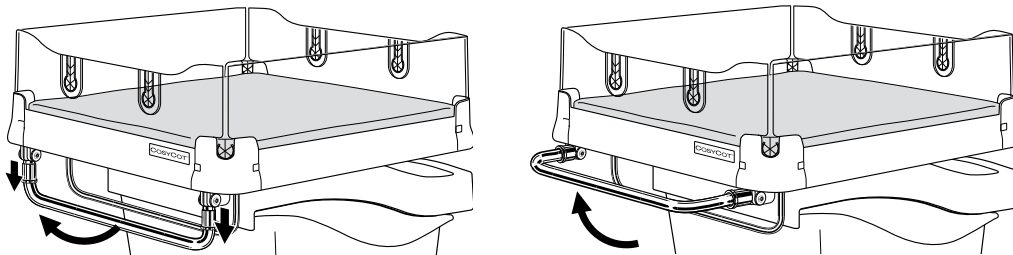

- (d) **How to use the lift and fold-down sides**
  - i To open the lift and fold-down sides:
    - Lift the top of the side panel and fold down over the edge of the bassinet.

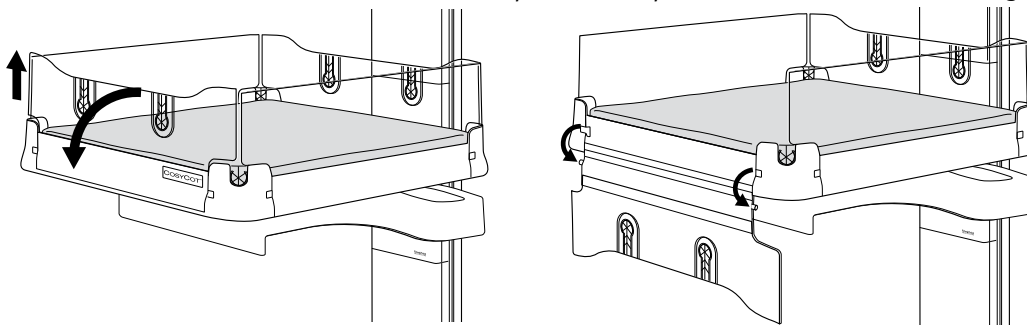

- ii To close the lift and fold-down sides:
  - Fold up the side panel and lift over the recess to engage the side panel to the bassinet.
- iii To remove a side panel:
  - Lift and retract the moveable pin by operating the latch and slide out the fixed pin.
- iv To replace a side panel:
  - Engage the fixed pin in the lower recess, retract the moveable pin and release into the lower slot.

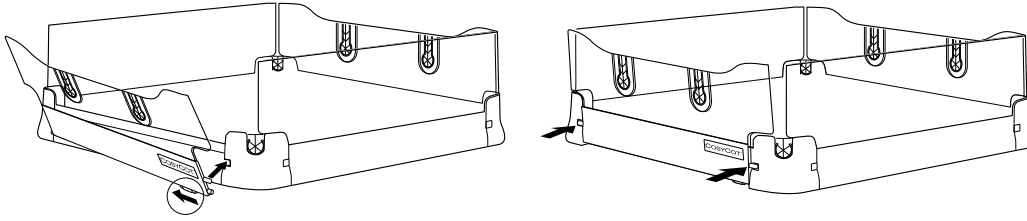

### (e) Bassinet Tube holders

- i The **CosyGrip™** tube holders located in the rear and front panels are designed to accommodate cables and tubing up to 22 mm in diameter. The **CosyGrip™** tube holders are designed to hold tubes in place and can be removed for cleaning. Using the **CosyGrip™** tube holders restricts the rear and front panel ability to be lowered.
- ii The **CornerGrip™** tube holders located in the four corners of the bassinet have been designed to accommodate cables and tubing up to 15 mm in diameter. The lift and fold down sides do not affect tubes and cables in the **CornerGrip™** tube holders.

### (f) Bassinet

#### **WARNINGS**

- **Maximum bassinet loading is 10 kg (22 lb).**
- **Ensure the bassinet is level and side panels are locked into position before transport. Use transport handle and ensure the drawer is in the central position.**
- **Do not move the warmer by pushing or pulling on the bassinet side panels. This action may lead to the deterioration and breakage of the components that act as a safety barrier around the baby.**
- **Tilting the bassinet from the horizontal position can affect warmer performance by altering the heat distribution across the bassinet mattress.**
- **Inspect all tubes or wires connected to the baby before and after tilting bassinet. Tilting or moving the warmer bassinet can pull on tubing or leads.**
- **Do not leave the baby unattended in the bassinet when the side panels are folded down.**
- **Regularly check side panels are securely locked in the vertical position.**

# Chapter 3 - Using Your Warmer

## 11. Raising and Lowering the Mobile Stand - IW910/920

(a) About raising & lowering the mobile stand

- i The mobile stand allows the heater to be easily raised or lowered to the correct height of 68cm above beds, bassinets or theatre and examination tables of various heights above the floor.

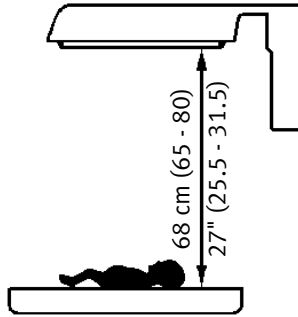

(b) How to raise or lower the mobile stand

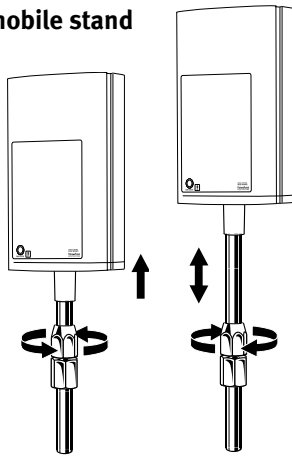

- i Grip the lower half of the mobile stand and loosen the locking nut.
- ii Observe the height of the bassinet, cot or examination table on the scale on the lower half of the mobile stand.
- iii Raise or lower the heater head and controller until the same height is shown just above the locking nut.
- iv Tighten the locking nut. The mobile warmer is ready for use.

(c) Transport

**WARNING**

- Ensure the mobile stand is adjusted to the lowest position before transport.

## 12. Alarm Systems

(a) About alarm systems

The following section describes the alarm systems, possible causes, and suggested actions.

In accordance with IEC 60601-1-8, the following alarms are considered MEDIUM PRIORITY alarms.

i Check Baby



The indicator light will flash, an audible alarm will sound, and the heater power level will be reduced to 25% if the warmer has been operating either in Baby mode at 100% power or in Manual mode at more than 25% power, for longer than 15 minutes. Pressing the Audio Pause or relevant mode button cancels the alarm and recommences heating.

**Possible Cause**

- 1 In Baby mode: The skin temperature measurement may be incorrect due to skin sensor placement.
- 2 In Manual mode: The heater power was set higher than 25% for longer than 15 minutes.

**Action to Take**

- 1 Check the skin sensor placement, then press the Audio Pause or Baby button to re-commence heating.
- 2 Adjust the heater power to less than 25%, or press the Audio Pause or Manual button to re-commence heating.

## ii High Skin Temp



### Baby control only

The indicator light will flash, an audible alarm will sound, and the heater will be disabled if the baby skin temperature is greater than the set temperature by 1°C. Pressing the Audio Pause button silences the audible alarm for 10 minutes, while the indicator light will remain flashing until the baby skin temperature is within 1°C of the set temperature. In Prewarm or Manual mode this alarm will occur if the baby skin temperature is greater than 39°C.

#### Possible Cause

- 1 The set temperature may have been adjusted lower by more than the alarm limit.
- 2 The baby may be experiencing heat stress.

#### Action to Take

- 1 Press the Audio Pause button and wait for the baby's skin temperature to fall.
- 2 Check the baby's clinical condition.

## iii Low Skin Temp



### Baby control only

The indicator light will flash, an audible alarm will sound, and the heater power level will be reduced to 25% if the baby skin temperature is less than the set temperature by 1°C. Pressing the Audio Pause button silences the alarm for 10 minutes and re-enables heater power, while the indicator light will remain flashing until the baby skin temperature is within 1°C of the set temperature. This alarm is not active in Prewarm or Manual mode, and is disabled during initial warm-up for 15 minutes, or until the baby skin temperature has warmed up to the set temperature.

#### Possible Cause

- 1 The set temperature may have been adjusted higher by more than 1°C
- 2 The skin sensor and cover may have been accidentally covered.
- 3 The skin sensor may have been detached or is incorrectly positioned.
- 4 The baby may be experiencing cold stress.

#### Action to Take

- 1 Press the Audio Pause button and wait for the baby's skin temperature to rise.
- 2 Remove the object which is covering the skin sensor
- 3 Check the skin sensor and reattach or reposition as required.
- 4 Check the baby's clinical condition.

## iv Sensor Disconnect



### Baby control only

The indicator light will flash, an audible alarm will sound, and the heater will be disabled if the skin sensor is either removed or faulty. Pressing the Audio Pause button silences the alarm for 10 minutes, while the indicator light will remain flashing and the heater remains disabled until the skin sensor is plugged in or replaced. This alarm does not indicate if a sensor is removed in Manual mode, and is not active in Prewarm mode.

This alarm will override High & Low Temp Alarms in Baby Control Mode only.

#### Possible Cause

- 1 The skin sensor may not be connected to the warmer.

#### Action to Take

- 1 Check the connections of the skin sensor plug into the front panel socket or the connection between the single use skin sensor and the adaptor 900IW003 and the adaptor socket connection.

# Chapter 3 - Using Your Warmer

## v See Manual



- 2 The skin sensor may be faulty.
- 2 Replace the skin sensor. Have the suspect skin sensor checked by a technician.

If this indicator is flashing or illuminated continuously a fault has been detected or the overheat protector in the heater has tripped. For both faults the warmer should be immediately disconnected from the wall supply outlet, the baby relocated onto another warmer, and the unit sent for servicing.

This alarm will override all other alarms except POWER FAIL.

### Possible Cause

- 1 A software fault has been detected.
- 2 An electronic fault has been detected.

### Action to Take

- 1 Send warmer for servicing.
- 2 Send warmer for servicing.

## vi Power Fail

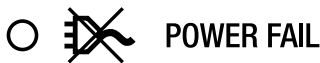

The indicator light will flash and an audible alarm will sound if the power supply to the warmer has failed. If the power on/off switch is on, then either the wall supply outlet has been switched off, or the warmer power cord has been unplugged from the wall supply outlet.

This alarm will override all other alarms.

### Possible Cause

- 1 The wall supply to the warmer has failed.
- 2 The wall supply to the warmer has been switched off accidentally.
- 3 The power cord has been accidentally unplugged while the warmer is in use.

### Action to Take

- 1 Turn the power switch off to cancel the audible and visual alarms. We recommend providing an alternative source of warmth for the baby.
- 2 Turn the wall supply switch on to restart the warmer.
- 3 Plug the cord back into the wall supply outlet.

## (b) Alarm system verification

The following procedure can be used to verify the operation of auditory and visual alarms.

### CAUTION

Before commencing ensure:

- A baby is not present on the warmer.
- There is no skin sensor connected into the front panel socket.
- The power cord is plugged into an appropriate wall supply outlet.

i Press the Power On/Off switch to the On position

ii **Check** the power-on alarm sounds briefly

iii **For a Baby control model:**

**Check** the indicator lights for the Check Baby, High Skin Temp, Low Skin Temp, and Sensor Disconnect alarms are illuminated briefly.



### **For a Manual control model:**

**Check** the indicator light for Check Baby is illuminated briefly.

- iv Change to Prewarm mode.
- v Unplug the power cord from the wall supply.
- vi **Check** the Power Fail indicator light flashes and audible alarm sounds.
- vii Press and hold the Prewarm button. Plug the power cord into the wall supply outlet.
- viii **Check** the warmer re-starts correctly, the See Manual indicator light flashes and audible alarm sounds.
- ix Press the Power On/Off switch to the Off position.

If steps ii, iii, vi and viii produce the desired results, the warmer can be returned to use. If any of steps ii, iii, vi or viii do not produce the desired results, then send the warmer for servicing.

### **13. Information Signals**

Activation of the procedure timers is confirmed by a single tone 'beep'.

Activation of the Light and Apgar Timers and selection of a power mode is confirmed by a single tone 'beep' and green LED.

### **14. Shut Down Procedure**

Once the warmer is no longer required for therapy, the following actions will safely shut down the equipment:

- Turn off the power switch on the control panel.
- Disconnect the skin sensor and clean as applicable.

# Chapter 4 - Accessories

## 1. Skin Sensors & Sensor Covers

(a) **About the 900IW001 DuoSense™ skin sensor**

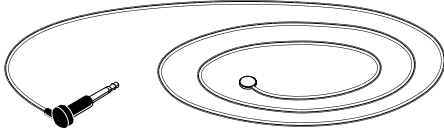

- i The 900IW001 DuoSense™ skin sensor measures the baby's skin temperature using two independent sensors that are continuously compared to ensure accurate and reliable skin temperature measurements.

(b) **About the NC02x SureSense™**

- i The Single Patient Use temperature sensors measure the baby's skin temperature using a single thermistor rated to +/- 0.1°C accuracy and good skin surface area contact.

(c) **About the sensor covers NC040-10 NC041-10 (MINI)**

- i The reflective sensor cover firmly yet gently attaches the skin sensor to the baby while its reflective and insulating nature shields the skin sensor from external sources of heat.
- ii The sensor covers are single-baby multi-use items, which can be placed, gently removed, then re-wet before re-use.
- iii Each sensor cover pack contains 10 sensor covers.

## 2. Electric Elevator Module

**Before use**

Please read and understand all instructions before using the electric elevator module and related accessories with the warmer.

(a) **About the electric elevator module**

- i The electric elevator modules raise or lower the warmer bassinet from 87 to 98 cm (34.3"- 38.6") at the touch of a button.  
*Different voltage options available*

(b) **Using the electric elevator module**

- i Ensure isolating switch is on.
- ii To raise the bassinet press the up ↑ button on the right-hand leg.
- iii To lower the bassinet press the down ↓ button on the right-hand leg

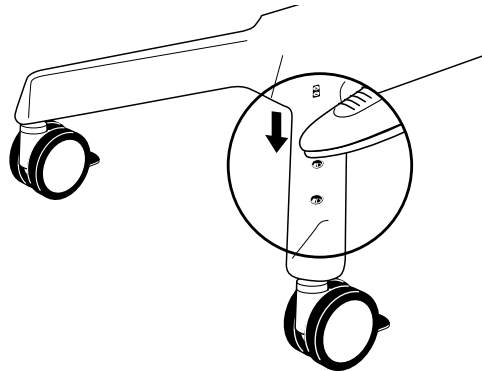

(c) User

**WARNINGS**

- Care should be taken to ensure that the maximum total accessory weight on the warmer does not exceed the maximum specified. Refer to the “Specification for IW93x and IW95x CosyCot™ Infant Warmer” located at the back of this operating manual.
- Ensure that all limbs are clear of moving parts under the base and legs while operating the electric elevator.
- Be careful not to dislodge feeding tubes/respiratory lines from the patient when operating the electric elevator base.
- Unlock the front wheels before raising or lowering the bassinet.

(d) Operation

**CAUTION**

- Ensure there is adequate clearance above and below the warmer before raising or lowering the electric elevator module.
- Do not stand on the base and legs or climb onto any part of the warmer.
- To avoid overheating the electric elevator motor, do not continuously raise or lower the warmer bassinet.
- Avoid pulsing the up and down buttons.

### 3. Gas System Accessories

**Before use**

Please read and understand these instructions before using the gas system accessories and related accessories with the warmer.

(a) About gas system accessories

- i The 900 series gas system accessories provide reliable gas supply from standard gas cylinders or regulated hospital pipeline systems.

(b) Gas supply modules

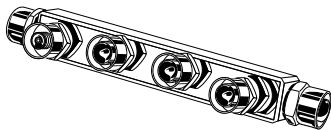

- i The 900IW100 series Gas Supply Modules combine the flexibility of dual gas cylinders and hospital pipeline system gas inlets and outlets with readily accessible panel mounted flowmeter modules.
- The Flowmeter Modules are available with either two oxygen flowmeters or one oxygen and one air flowmeter. Please refer to page 4-4 for further Flowmeter Module information.

*Different gas and inlet/outlet options available*

(c) Gas accessory blocks

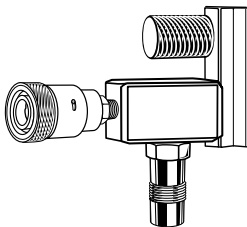

- i The 900IW150 series Gas Accessory Blocks provide a single oxygen or air gas outlet from either a Gas Supply Module or regulated hospital pipeline system. The single gas outlet can be used for flowmeters or venturi suction units.
- ii The Gas Accessories are available with DISS, NIST, and Australian gas fittings.

## Chapter 4 - Accessories

### (d) Gas cylinder installation

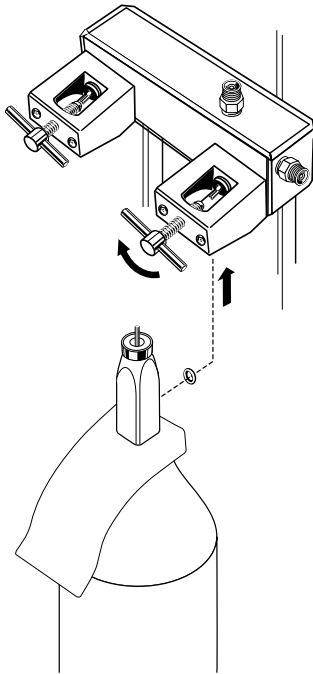

To install gas cylinders in either the Gas Supply Module or Gas Cylinder Block:

- i Check and clear all connections of oil, grease and foreign material. Ensure damaged connections are correctly serviced before use.
- ii Turn the tee handle counter-clockwise until the tip of tee screw is almost flush with the inside face of the cylinder yoke. Remove the cylinder dust cap if fitted.
- iii Carefully open then immediately close the cylinder valve to blow any foreign debris from the cylinder valve outlet. During this operation ensure you are standing next to the cylinder and not in front of the cylinder valve.
- iv Ensure the valve is closed without excessive force
- v Remove and replace the cylinder gasket from the yoke nipple. Ensure fresh gaskets are used for every new cylinder.
- vi Reusable Bodock washer does not need replacing each change.
- vii Carefully install the cylinder over the yoke nipple and index pins. Turn the tee handle clockwise to hold the cylinder firmly in place. Avoid over-tightening the tee handle.
- viii SLOWLY open cylinder valve one full turn. The gas supply module is now ready for use.

The Gas Supply Module with dual oxygen cylinders uses individual check valves to allow replacement of an empty cylinder while the other cylinder is in use. Promptly replace empty cylinders.

#### Before, during and after use

##### **WARNINGS**

- **Ensure the cylinder valves are closed when the hospital pipeline systems are in use. Supply pressures may become equal and if used simultaneously, cylinder supplies could be exhausted leaving no emergency backup supply.**
- **Compressed gas cylinders can become hazardous projectiles if the gas is released rapidly. To prevent damage from shock or impact, the cylinders must be securely fastened.**

## 4. Flowmeter Modules

### Before Use

Please read and understand all instructions before using the flowmeter modules and related accessories with the warmer.

#### (a) About flowmeter modules

- i The Oxygen Flowmeter Modules (900IW110,112) and Oxygen/Air Flowmeter Modules (900IW111,113) provide an accurately controlled flow of oxygen/air (0 to 15 L/min).

#### (b) Using the flowmeter modules

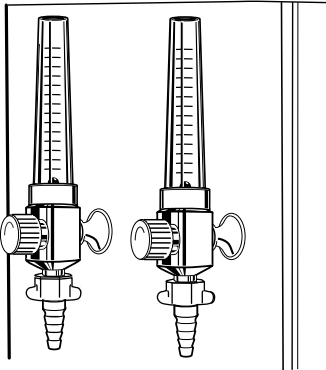

- ii Before use always check the oxygen and/or air cylinder and the hospital pipeline supply to the warmer.
- iii Check the flowmeter nipple is hand-tight.
- iii Connect the patient supply tube to either of the flowmeter nipples using firm hand pressure.
- iv Connect the other end of the patient supply tube to the intended device, for example, a Fisher & Paykel humidifier, Neopuff™ Infant Resuscitator, headbox, or oxygen therapy system.
- v Adjust the flowmeter valve to the desired flow rate. Ensure all gas supply and patient lines are regularly inspected for possible leaks during use.

#### (c) Oxygen administration

### WARNING

- **Oxygen-enriched gas has been found to increase the risk of retinopathy of prematurity. Use arterial blood gas measurement for regulation of inspired oxygen concentration when oxygen-enriched gas is necessary.**

## 5. X-Ray Tray Module

### Before use

Please read and understand all instructions before using the x-ray tray and related accessories with the warmer.

#### (a) About the x-ray tray

- i The 900IW205 x-ray tray combines a non-slip surface with a grid reference label for accurate placement of the x-ray cassette beneath the bassinet without disturbing the baby. The heater can be rotated to the left or right to allow access for x-ray equipment.

#### (b) Using the x-ray tray

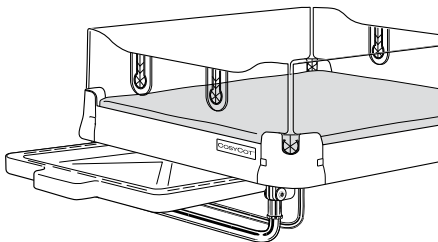

- ii Grasp the x-ray tray handle beneath the front of the warmer bassinet, and pull out the cassette drawer.
- iii Align the x-ray cassette in the drawer using the grid reference label on the bassinet side panels and drawer base.
- iii Push the cassette drawer back beneath the warmer bassinet. A 'click' will be felt when the drawer is latched.
- iv Rotate the heater out of the way, position the x-ray machine and take the x-ray.

### WARNINGS

- **Maximum loading 2 kg (4.4 lb).**
- **Never place a baby on the x-ray cassette tray.**

# Chapter 4 - Accessories

## 6. Mounting Accessories

### Before use

Please read and understand all instructions before using the mounting accessories with the warmer.

#### **WARNING**

- Care should be taken to ensure that the maximum total accessory weight on the warmer does not exceed the maximum specified. Refer to the “Specification for IW93x and IW95x CosyCot™ Infant Warmer” located at the back of this operating manual.

### (a) About the mounting accessories

### (b) Using the mounting accessories

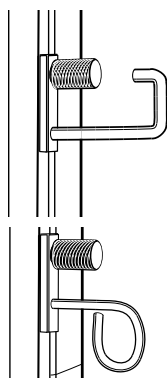
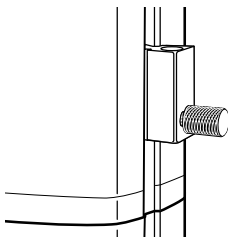
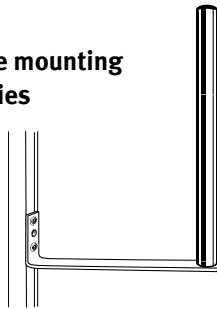

- i The mounting accessories provide various methods of attaching warmer accessories and alternative supplier products onto the warmer.

#### **WARNING**

- **Maximum loading for 900IW302 Long Mounting Pole is 20 kg (44 lb).**

### i **900IW301 Short Mounting Pole & 900IW302 Long Mounting Pole**

These accessories are used to mount Fisher & Paykel humidifiers, oxygen/air blenders, and syringe pumps onto the warmer column. The Short Mounting Pole is shown The Long Mounting Pole extends the full length of the column.

#### **WARNING**

- **Maximum loading for 900IW301 Short Mounting Pole is 5 kg (11 lb).**

### ii **900IW303 Side Shelf Mounting Block**

This accessory is used to mount the side shelves onto the warmer column.

#### **WARNING**

- **Maximum loading 15 kg (33 lb).**

### iii **900IW314 Dovetail Channel Rail Bracket**

This accessory is used to mount the neoBLUE® mini onto the warmer column.

#### **WARNING**

- **Maximum loading 5 kg (11 lb).**

### iv **900IW305 Cable/Hose Hook**

This accessory provides an adjustable point for convenient, tidy storage of power cables, oxygen and air hoses, especially useful during transportation.

#### **WARNING**

- **Maximum loading 5 kg (11 lb).**

### v **900IW306 Accessory Hook**

This accessory can be used to mount medication and irrigation bags, stethoscopes, cables, clipboards and catheters on the warmer column and from beneath the warmer bassinet.

#### **WARNING**

- **Maximum loading 2 kg (4.4 lb).**

### vi **900IW313 IV Pole bent Quad Hook**

This accessory can be used to mount medication and irrigation bags at elevated heights to provide constant feed systems. It can be mounted on the same side as a long mounting pole.

#### **WARNING**

- **The maximum weight limit for each Cable/Hose Hook is 1 kg (2.2 lbs), or a total weight of 4 kg (8.8 lbs).**
- **Not for use with IW910/920 Mobile Warmers.**

## 7. Storage Accessories

### Before use

Please read and understand all instructions before using the storage accessories with the warmer.

#### **WARNING**

- **Care should be taken to ensure that the maximum total accessory weight on the warmer does not exceed the maximum specified. Refer to the “Specification for IW93x and IW95x CosyCot™ Infant Warmer” located at the back of this operating manual.**

### (a) About the storage accessories

- i The storage accessories provide various methods of storing warmer accessories and alternative supplier products onto the warmer.

### (b) Using the storage accessories

#### i **900IW401 Side Shelf**

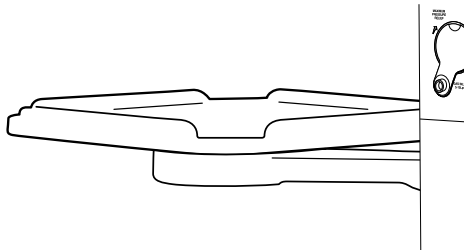

- This accessory provides an easily positioned surface for monitors, syringe pumps and other large items. The side shelf attaches to the IW930 or IW950 using the supplied 900IW303 shelf support block.

#### ■ To install and use the Side Shelf:

- Slide the shelf support block into the column mounting slot and tighten the lock knob at the desired side shelf height.
- Guide the side shelf pin into the shelf support block.
- Place items on the side shelf and position as required.

#### **WARNING**

- **Maximum loading 15 kg (33 lb).**

#### ii **900IW408 Storage Drawer System**

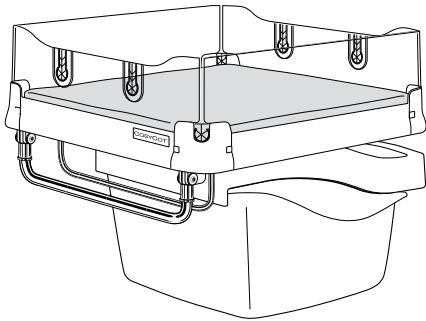

- The storage drawer system consists of a slide out drawer system, which provides convenient and easy storage for larger items such as sheets, blankets and diapers. Inside the main storage drawer is a multipurpose tray that provides storage for smaller items such as catheters, swabs and syringes.

#### **WARNING**

- **Do not exceed the maximum total storage drawer loading of 7 kg (15.4 lb).**

#### iii **900IW230 neweigh™ Infant Scales**

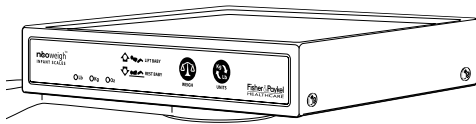

- The neweigh™ Infant Scales are designed for the CosyCot™ Infant Warmer, incorporating an in-bed load cell design. They have simple and easy to use one-touch controls conveniently intergrated into a useful side shelf.

#### **WARNING**

- **Maximum loading 15 kg (33 lb).**

## 8. Uninterruptible Power Supply (UPS) for transport warmer

900IW505X

### Before use

Please read and understand these instructions and refer to the Powervar User Guide before using the uninterruptible power supply and related accessories with the warmer.

### WARNINGS

- Care should be taken to ensure that the maximum total accessory weight on the warmer does not exceed the maximum specified. Refer to the “Specification for IW93x and IW95x CosyCot™ Infant Warmer” located at the back of this operating manual.
- Recharge the UPS for >24 hours before returning to service (note that the use of the UPS before charging has completed will lead to reduced run time).

### (a) About the UPS transport system

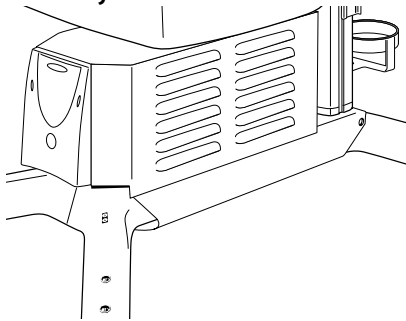

- i The UPS provides power during transportation and may be fitted to an IW930/ IW950 Series. Two components are required to provide an uninterruptible power supply (UPS), the UPS itself and a mounting kit 900IW312 to secure it to the CosyCot™ Infant Warmer.

The UPS provides constant warming for ~ 8 minutes @ 100% power and ~ 20 minutes @ 50% power with > 24 hours charge time.

### (b) Turning on the Warmer

- i The UPS will not immediately power up once plugged into the wall supply.
- ii In order to start the UPS the power button at the front of the unit must be held down for 3 seconds.
- iii The UPS will emit a tone to indicate that it is operational.
- iv A low battery LED and audible alarm will sound if the battery has insufficient charge for a transport.
- v Once the UPS has been turned on it should now be possible to turn the warmer on.
- vi The warmer will power up as normal.

### (c) Using the Warmer for Transport

#### i Immediately before transport

#### CAUTION

- Ensure that the inspection lamp is off.
- Ensure that any peripheral devices that may draw power from the warmer are either turned off or disconnected.
- Remove the cable that connects the UPS to the wall power supply.
- The UPS should start emitting an audible alarm to indicate that the UPS is now on battery power.

#### During Transport

- i As the battery reserves decrease, the frequency of the audible alarm increases, and a battery status LED display decreases from 5 segments to none.
- ii This gives continuous feedback of how much longer you have to transport with warmer power.
- iii The cable that connects the UPS to the wall supply should be immediately plugged back into the wall upon arrival at the transport destination.



- iv The audible alarm should cease as soon as this done.
- v Check the warmer display to ensure that the infant warmer is running.

### After transport

- i The warmer must be left connected to the wall for at least 24 hours, before it is returned to transport service.

### (d) Functional Test

#### CAUTION

- Ensure that UPS has been fully charged for > 24 hours.
- Set the CosyCot™ to manual mode.
- Dial the control knob clockwise until the power bar displays 100%.
- Disconnect the UPS from the mains supply.
- The UPS should indicate battery status via the LED's (Battery Monitor) and emit an audible tone.
- Ensure that the UPS battery is able to power the warmer for greater than 8 minutes.
- Recharge the UPS for > 24 hours before returning to service.

#### WARNINGS

- The UPS and following warnings are only intended for use with the Fisher & Paykel Healthcare CosyCot™ Infant Warmer.
- CosyCot™ will not operate from mains without UPS switched on (Hold Power On/Off button for > 3 sec).
- Do not cover air vents on shroud (cover).
- Perform a functional test on the battery every month after 6 months use.
- Change the battery every 12 months if usage is typically 2-3 times/ week.
- Ensure wraps or blankets are available as back up in the event of UPS battery failure.

## 9. Phototherapy Accessories

### Before use

Please read and understand these instructions before using the neoBLUE®mini LED phototherapy system with the warmer.

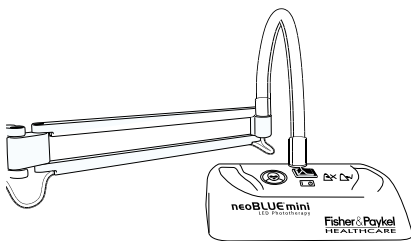

### i About Phototherapy

The 900IW510 – neoBLUE®mini LED phototherapy system provides convenient and effective treatment for hyperbilirubinemia in neonates.

The lightweight plastic enclosure contains light emitting diodes (LEDs) which deliver a narrow band of high intensity blue light 450 – 470nm.

The neoBLUE®mini LED Phototherapy System can be mounted onto either side of the CosyCot™ Infant Warmer column using the Dovetail Channel Rail Bracket 900IW314 or can be mounted to a pole using 900MR030.

## Chapter 4 - Accessories

### (a) How to install the Phototherapy Lamp Head

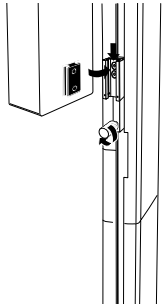

- i Slide the support bracket (900IW314) into either side of the CosyCot™ Infant Warmer column and set to the desired height.
- ii Slide the mounting tongue into the support bracket.

### (b) Using Phototherapy

For full details on use and service of the neoBLUE® mini LED phototherapy system please refer to Fisher & Paykel Healthcare neoBLUE® mini user manual pn. 185043922 and the Fisher & Paykel Healthcare neoBLUE® mini service manual 185043921.

#### **WARNINGS**

- **This product is intended for use by authorized and qualified personnel who are aware of currently known hazards and benefits of phototherapy for treatment of hyperbilirubinemia.**
- **All personnel must be familiar with the operation of the neoBLUE® mini phototherapy system before using the device with patients.**
- **Protect baby's eyes and genitals from Phototherapy light.**
- **Do not look directly at the blue light.**
- **Ensure the neoBLUE® mini LED phototherapy unit is securely fitted to the mounting bracket.**
- **Only qualified personnel should carry out service and maintenance procedures.**

#### CAUTION:

- US Federal law restricts this device to sale by or on the order of a physician.
- Do not autoclave or gas sterilize any part of the neoBLUE® mini LED Phototherapy system.
- Do not use solvents or abrasive cleaning solutions for cleaning surfaces of the Phototherapy System. Use of alcohol for cleaning acrylic surfaces can cause crazing and cracking.
- Do not place the neoBLUE® mini LED Phototherapy system directly under the Warmer head.
- Ensure all warmer parts and accessories are checked before returning the device to service.

#### *NOTE:*

- To be effective there should be no obstruction between the patient's skin and the therapeutic blue light.
- The phototherapy system does not interfere with the Infant Warmer control.

## 1. Cleaning

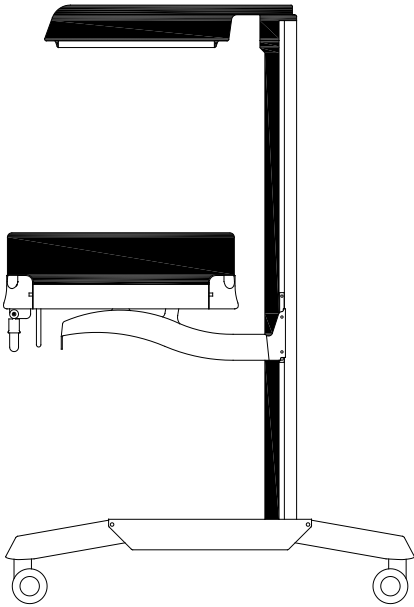

### Before you begin

#### **WARNINGS**

- To avoid the possibility of burns when performing cleaning procedures, ensure the Infant Warmer is disconnected from the power supply by removing the plug from the mains outlet and the heater element is allowed to cool for one hour, or until cool to the touch.
- To avoid the possibility of electric shock hazard when performing cleaning procedures, ensure the Infant Warmer is disconnected from the power supply by removing the plug from the mains outlet.
- If the 900IW505x Battery Module is installed on the CosyCot™ Infant Warmer, please ensure the 900IW505x Battery Module is powered off prior to cleaning. Do not remove the 900IW312x Battery Module Shroud during cleaning procedures. Ensure no part of the 900IW505x Battery Module is immersed in any cleaning agent.
- Do not allow cleaning liquids or cleaning solutions to enter into electrical housings.
- Do not allow cleaning liquids or cleaning solutions to collect around or enter into oxygen or air fitting.
- Ensure all oxygen and air supplies are turned off and disconnected from the CosyCot™ Infant Warmer before performing cleaning procedures. Explosion and fire hazards can exist when performing cleaning procedures in an oxygen-enriched environment.

### (a) General Procedures

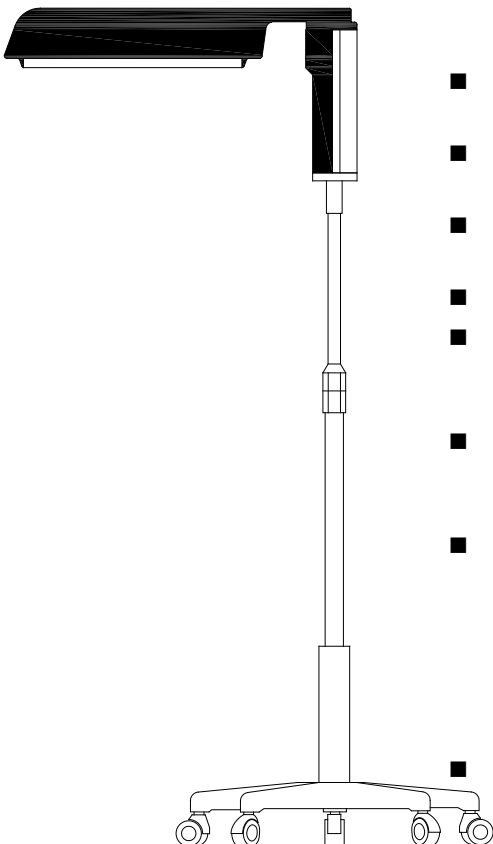

Clean the Infant Warmer and accessories either weekly or between patients using the following cleaning procedures:

#### CAUTION

- Comply with hospital, local and national guidelines for product cleaning frequencies.
- Cleaning shall be performed at ambient conditions. Allow heated surfaces to cool for at least one hour or cool to the touch before cleaning.
- Before cleaning, remove and discard all used disposable products using the recommended method of disposal.
- Dust all surfaces with a clean damp soft cloth.
- Clean all plastic surfaces with detergent based solution (maximum 2% in water) ensuring the manufacturer's directions for use of the cleaning agent are followed.
- The plastic surfaces highlighted in black contain plastic components made from polycarbonate or acrylic, and include the entire heater assembly, bassinet side panels, column cap and front panel fascias.
- The following proprietary chemical cleaning wipes (and their manufacturer) are recommended if the highlighted plastic surfaces require cleaning for infection control purposes.
  - **Caviwipes™ (Metrex Research Corporation)**
  - **Sani-cloth® HB (Professional Disposables, Inc.)**
  - **Asepti-Wipes™ II (Ecolab, Inc.)**
- Dry all surfaces after cleaning with a clean soft cloth or paper towel.

## Chapter 5 - Cleaning and Maintenance

### CAUTION:

- Ensure no part of the Infant Warmer or related accessories is immersed in any cleaning liquid or cleaning solution.
- Do not clean the infant radiant warmer heating element.

### *NOTE:*

The recommended chemical cleaning wipes listed above have been checked for long term compatibility with the IW900 Series Infant Warmers.

### CAUTION:

- Do not clean the highlighted plastic surfaces with proprietary cleaning products containing either hydroxides, hypochlorites, peroxides, gluteraldehyde or cleaning products with a greater than 30% alcohol base.
- The chemicals used in these proprietary cleaning products may lead to discolouration, crazing and eventual cracking of the highlighted plastic surfaces.

**Examples** of proprietary cleaning products which contain such cleaning chemicals include but not limited to:

Asepti-Wipes™ (Ecolab, Inc)

Clorox® (The Clorox Company)

Endbac 256 (Johnson Wax Professional)

Quat (3M)

Sporiciden (Liberty Industries, Inc)

Sporox® II (Sultan Healthcare)

Steris (Steris Corporation)

Terralin® (Schülke & Mayr)

Virtek® (A Virtek Company)

Virox® (Virox Technologies)

- Do not use abrasive cleaning solutions.
- Ensure all Infant Warmers and accessories are checked before returning the Infant Warmer to service.

### **(b) Skin sensors**

- i Clean the 900IW001 DuoSense™ skin sensor with alcohol, or detergent or soap solution (maximum 2% in water), ensuring the manufacturer's directions for use of the cleaning agent are followed.
- ii Apply the cleaning solution with a clean cloth or sponge, and dry all surfaces after cleaning with a clean soft cloth or paper towel.

### CAUTION

- Do not autoclave or gas sterilise the 900IW001 DuoSense™ skin sensor.
- Do not pull on the sensor cup or sensor plug during cleaning or drying as the skin sensor may be damaged.
- Ensure the skin sensor is only removed from the controller by grasping the plug at the front panel. Ensure excessive strain is not placed on the sensor lead either during use, cleaning or inspection.

- (c) **Mattress**
- i Clean the mattress with an approved and correctly diluted disinfectant-detergent solution, ensuring the manufacturer's directions for use of the cleaning agent are followed.
  - ii Apply the cleaning solution with a clean cloth or sponge, and dry all surfaces after cleaning with a clean soft cloth or paper towel.
- CAUTION
- Do not autoclave the mattress.
- (d) **After cleaning**
- CAUTION
- Ensure all warmer parts and accessories are checked before returning the device to service. Refer to relevant sections of this operating manual for directions.
- (e) **Sterilisation**
- CAUTION
- Do not autoclave or gas sterilise any part of the warmer.
  - For cold sterilisation: Ensure the cold sterilisation agents are safe for use with the relevant warmer surfaces. If in doubt check with supplier.
  - For chemical liquid immersion: Some chemicals can be harmful to plastics. If in doubt check with supplier.

## 2. Maintenance

### Before you begin

#### **WARNINGS**

- **Only qualified personnel should carry out service and maintenance procedures.**
- **To avoid the possibility of burns when performing maintenance procedures, ensure the warmer is disconnected from the power supply by removing the plug from the mains outlet and the heater element is allowed to cool for one hour.**
- **To avoid the possibility of electric shock hazard when performing maintenance procedures, ensure the warmer is disconnected from the power supply by removing the plug from the mains outlet.**
- **Ensure all oxygen and air supplies are turned off and disconnected from the warmer before performing maintenance procedures. Explosion and fire hazards can exist when performing maintenance procedures in an oxygen-enriched environment.**
- **Care should be taken to ensure that the maximum total accessory weight on the warmer does not exceed the maximum specified. Refer to the "Specification for IW93x and IW95x CosyCot™ Infant Warmer" located at the back of this operating manual.**

(a) **General**

CAUTION

- After any maintenance is completed, ensure the equipment is functioning correctly in accordance with the published performance specifications.
- Refer to Alarm System Verification on page 3-12.
- Ensure only approved replacement parts are used during service and maintenance procedures.
- Please refer to the IW900 Series Infant Warmer Technical Manual (pn 185048310) for servicing information.
- Please contact an authorised Fisher & Paykel representative for further assistance with any servicing or maintenance requirement.

## Chapter 5 - Cleaning and Maintenance

- (b) **Bassinet & x-ray tray**
- i The bassinet should be checked annually to ensure reliable operation. The following procedure should be used by your technician:
    - Check each bassinet side panel for smooth operation and correct latching. Replace if defective.
    - Check x-ray tray module for smooth operation and correct placement of x-ray cassette. Replace if defective.
    - Check the operation of the transport handle and release collars.
    - Check the operation of the tilt mechanism for smooth movement and that the central détente can be felt.
    - Check that the two M8 shoulder bolts, which the bassinet pivots on, are not loose. Tighten if necessary.
- (c) **Base**
- i The base should be checked at least annually to ensure reliable operation. The following procedure should be used by your technician:
    - Check all base fittings are secure. Please refer to the IW900 Series Infant Warmer Technical Manual (pn 185048310) for adjustment information.
    - Check the operation and electrical connections of the electric elevator if fitted.
    - Check castors rotate freely and castor brakes operate correctly.
    - For mobile warmers ensure the stabilizer weight bolt is tight and that the pole is fully engaged into the warmer support bracket.
- (d) **Heater Head**
- i At least annually check the heater head swivel is secure.
  - ii Ensure the head pivot nut is locked/glued in place. Check the swivel movement of head is free and that the central détente can be felt.
- (e) **Storage Drawers**
- i Ensure the drawer slides smoothly. If required clean and grease the sliders with a food grade, non-drying grease.
- (f) **After maintenance**
- CAUTION
- Ensure all warmer parts and accessories are checked before returning to service. Please refer to relevant sections of this operating manual.

# Chapter 6 - Troubleshooting

## 1. General Assistance

### (a) About trouble-shooting

The troubleshooting charts provide the user with general situations, possible causes and suggested actions. If these charts cannot assist in solving the particular situation, the warmer should be sent for servicing.

Situation	Possible Cause	Actions to Take
Unable to provide stable control of the baby's skin temperature.	Skin sensor and/or sensor cover poorly attached to the baby.	Correctly re-attach the skin sensor and sensor cover (see page 3-3/3-4).
	Heat path between the baby and heater element is obstructed.	Remove heat path obstruction.
	A Low Skin Temp alarm exists, and the Audio Pause button has not been pushed to silence the alarm and re-enable the heater.	Press the Audio Pause button to silence the audible alarm and re-enable the heater.
	Warmer is operating in Manual or Prewarm mode.	Baby control models: Change to Baby mode, and adjust set temperature as desired. Manual control models: Change to Manual mode, and adjust heater power to achieve desired baby's skin temperature.
Baby's skin temperature readings do not appear correct.	Poor connection between skin sensor and the warmer	Push the skin sensor plug firmly into the front panel socket or the connector into the adaptor.
	Skin sensor faulty.	Check skin sensor performance and replace if defective.
	Skin sensor or sensor cover poorly attached to the baby.	Correctly re-attach the skin sensor and sensor cover (see page 3-3/3-4).
The <i>See Manual</i> light is illuminated or flashing and the audible alarm is sounding.	A software fault has been detected.	Send warmer for servicing.
	A hardware fault has been detected.	Send warmer for servicing.
The <i>Power Fail</i> light is flashing and the audible alarm is sounding.	The wall power supply to the warmer has been switched off.	Switch on the wall supply.
	The internal fuses, power cord or internal wiring may be defective.	Send warmer for servicing.

# Chapter 7 - Appendices

## 1. Product Specifications

### 1.1 IW910 and IW920 Mobile Infant Warmers

- (a) **Electrical specifications**
- i Supply Voltage & Current
    - 230 V~ ± 20 V~      2.2 A~ maximum
    - 120 V~                4.2 A~ maximum
  - ii Supply Frequency
    - 50/60 Hz
  - iii Nominal Power Consumption
    - 510 W      230 V~ model
    - 510 W      120 V~ model
  - iv Heater Power
    - 450 W
    - Mattress irradiance is 32 mW/cm<sup>2</sup> at 100% heater power and 68 cm (26.8") heater grill to mattress distance*
  - v Light Power
    - 20 W
    - Maximum intensity is 400 lux at 68cm (26.8") heater grill to mattress distance*
  - vi Temperature Range
    - Set temperature from 34.5°C to 37.5°C in 0.1°C steps
  - vii Temperature Measurement
    - Displayed range of 4.0°C to 50.0°C in 0.1°C steps
    - Sensor accuracy of ± 0.1°C
  - viii Temperature Sensor
    - Twin YSI 400 compatible thermistors with 100 MΩ insulation at 500V between all electrical contacts and the skin surface
- (b) **Mechanical specifications**
- i Height
    - Adjustable from 151 cm to 191 cm (59.4" to 75.2")
    - To suit bassinets from 71 cm to 111 cm (28" to 43.7")*
  - ii Width
    - 65 cm (25.6")
  - iii Depth
    - 110 cm (43.3")
  - iii Weight without accessories
    - 22 kg (48.5 lb)
  - iv Maximum Load
    - 4 kg (8.8lb) of Accessories, 26 kg (57.3 lb) total weight
  - v Heater head rotation
    - 130° to +130° from centre position
  - vi Castors
    - 5 x Ø 50 mm (2"), all locking



## 1.2 IW93x and IW95x CosyCot™ Infant Warmers

<b>(a) Electrical specifications</b>	i	Supply Voltage & Current		
		Voltage	Controller only	Including Accessories
		230 V~ ± 20 V~	2.2 A~ maximum	10 A~ maximum
		120 V~	4.2 A~ maximum	12 A~ maximum
	ii	Supply Frequency		
		50/60 Hz		
	iii	Power Consumption		
		1380 W	230 V~ model	<i>Including accessories (max)</i> (Pre-July 2012 = 2300 W)
		1200 W	120 V~ model	<i>Including accessories (max)</i> (Pre-July 2012 = 1440 W)
		510 W	<i>Controller and heater only</i>	
	iv	Heater Power		
		450 W	<i>- Mattress irradiance is 32 mW/cm<sup>2</sup> at 100% heater power.</i>	
	v	Light Power		
		20 W	<i>- Maximum intensity is 400 lux.</i>	
vi	Temperature Range			
	Set temperature from 34.5°C to 37.5°C in 0.1°C steps			
vii	Temperature Measurement			
	Displayed range of 4.0°C to 50.0°C in 0.1°C steps			
	Sensor accuracy of ± 0.1°C			
viii	Temperature Sensor			
	Twin YSI 400 compatible thermistors with 100 MΩ insulation at 500V between all electrical contacts and the skin surface			
<b>(b) Mechanical specifications</b>	i	Height	Adjustable from 170 cm to 186 cm (66.9" – 73.2") <i>With electric elevator module</i>	
			172 cm (67.8") <i>With standard fixed height option</i>	
	ii	Width	77 cm (30.3") - <i>Excluding shelves</i>	
	iii	Depth	103 cm to 129 cm (40.6" - 50.8") <i>Depends on accessories fitted, bassinet size and bassinet height</i>	
iv		Weight without accessories	<i>With electric elevator option</i> 67 kg (147 lb). <i>With standard fixed height option:</i> 55 kg (121 lb).	

## Chapter 7 - Appendices

v	Maximum Loading	<i>With electric elevator option</i> 73 kg (161 lb) of Accessories, (includes patient) <u>140 kg (308 lb) total weight.</u>
		<i>With standard fixed height option:</i> 85 kg (187 lb) of Accessories, (includes patient) <u>140 kg (308 lb) total weight.</u>
vi	Heater Grill To Mattress	68cm (26.8")
vii	Heater Head Rotation	-130° to +130° from centre position
viii	Mattress Height	87.8 cm to 103.6 cm (34.6" – 40.8") <i>With electric elevator option</i> 90.5 cm (35.6") <i>With standard fixed height option</i>
ix	Bassinet Size (Standard)	65 cm x 65 cm (25.6" x 25.6") <i>Standard Mattress size 62 cm x 62 cm (24.4" x 24.4")</i>
x	Bassinet Size (Long)	65cm x 75cm (25.5" x 29.5") <i>Long mattress size 62cm x 72cm (24.4" x 28.4")</i>
xi	Bassinet Side Panel Height	17cm (14cm front & rear) – <i>Measured from the bassinet</i>  26cm (23cm front & rear) – <i>With high side option</i>
xii	Bassinet Tilting Positions	-10° to +10° in 1/2° increments
xiii	Castors	4 x Ø100 mm (4") all locking

## 1.3 IW980 and IW990 Wall Mount Infant Warmers

- (a) **Electrical specifications**
- i Supply Voltage & Current
 

230 V~ ± 20 V~	2.2 A~ maximum
120 V~	4.2 A~ maximum
  - ii Supply Frequency
 

50/60 Hz
  - iii Nominal Power Consumption
 

510 W	230 V~ model
510 W	120 V~ model
  - iv Heater Power
 

450 W

*Mattress irradiance is 32 mW/cm<sup>2</sup> at 100% heater power and 68 cm (26.8") heater grill to mattress distance.*
  - v Light Power
 

20 W

*- Maximum intensity is 400 lux at 68cm (26.8") heater grill to mattress distance.*
  - vi Temperature Range
 

Set temperature from 34.5°C to 37.5°C in 0.1°C steps
  - vii Temperature Measurement
 

Displayed range of 4.0°C to 50.0°C in 0.1°C steps

Sensor accuracy of ± 0.1°C
  - viii Temperature Sensor
 

Twin YSI 400 compatible thermistors with 100 MΩ insulation at 500V between all electrical contacts and the skin surface
- (b) **Mechanical specifications**
- i Height 36 cm (14.2")
  - ii Width 20 cm (7.9")
  - iii Depth 76 cm (29.9")
  - iv Weight without accessories 7.4 kg (16.3 lb)
  - v Heater Head Rotation -130° to +130° from centre position *-Depends on installation*
- (c) **Mounting Instructions**
- Please refer to the IW900 Series Infant Warmer Service Manual P/N 185048310.

# Chapter 7 - Appendices

## 2. Standards and Approvals

Designed to conform to the requirements of:

EN / IEC 60601-1

EN / IEC 60601-1-2

EN / IEC 60601-2-21

AS/NZS 3200.1.0



For European Union only:

CE 0123

MDD Class IIb

## 3. Equipment classifications

Class I Medical Electrical Equipment

Type B Applied Part (Bassinet)

Type BF applied part (Temperature Sensor)

Continuous operation

IP Classification IPX0

Not suitable for use in the presence of flammable anaesthetics

## 4. Environmental specifications

	<b>Operating</b>	<b>Transport</b>	<b>Storage</b>
Temperature	18°C to 30°C	-10°C to 50°C	-10°C to 50°C
Humidity	0% to 90%	0% to 90%	0% to 90%
	Normal Nursery Handling	Normal Transport Handling	

## 5. General information

- i Fuses in the equipment should only be replaced by fuses of the correct type as indicated on the appropriate labels or in the service manual.
- ii Full technical description including circuit diagrams, parts list and service data is contained within the IW900 Series Infant Warmer Service Manual (P/N 185048310), copies of which are held by your supplier or may be obtained from Fisher & Paykel Healthcare.

### 6. Trademarks

Trademarks CosyCot™, DuoSense™, SunSpot™, Neopuff™, SureSense™, DaisyDot™ DaisyDot mini™ and NeoWrap™ are trademarks of Fisher & Paykel Healthcare.

### 7. DEVICE AND CONSUMABLES DISPOSAL

#### **Infant Warmer Disposal Instructions**

This device contains electronics. Please do not discard as regular waste. Dispose of electronics according to local guidelines.

#### **Consumable Disposal Instructions**

At the end of use, place Infant Warmer single use product in a waste bag and discard according to hospital protocol.

## For more information please contact your local Fisher & Paykel Healthcare representative

### Manufacturer

Fisher & Paykel Healthcare Ltd  
15 Maurice Paykel Place  
East Tamaki, Auckland 2013

PO Box 14 348 Panmure  
Auckland 1741  
New Zealand

Tel: +64 9 574 0100  
Fax: +64 9 574 0158  
Email: [info@fphcare.co.nz](mailto:info@fphcare.co.nz)  
Web: [www.fphcare.com](http://www.fphcare.com)

### Australia (Sponsor)

Fisher & Paykel Healthcare Pty Limited  
19-31 King Street, Nunawading,  
Melbourne, Victoria 3131.

Tel: +61 3 9871 4900  
Fax: +61 3 9871 4998

### Austria

Tel: 0800 29 31 23  
Fax: 0800 29 31 22

### Benelux

Tel: +31 40 216 3555  
Fax: +31 40 216 3554

### Brazil

Fisher & Paykel do Brasil  
Rua Sampaio Viana, 277 cj 21,  
Paraiso, 04004-000  
São Paulo - SP, Brazil

Tel: +55 11 2548 8002

### China

代理人/售后服务机构:  
费雪派克医疗保健(广州)有限公司,广  
州高新技术产业开发区科学城科丰路31  
号G12栋301号

电话: +86 20 32053486  
传真: +86 20 32052132

### Finland

Tel: +358 (0)405 406618  
Fax: +46 (0)8 36 6310

### France

Tel: +33 1 6446 5201  
Fax: +33 1 6446 5221

### Germany

Tel: +49 7181 98599 0  
Fax: +49 7181 98599 66

### India

Tel: +91 80 4284 4000  
Fax: +91 80 4123 6044

### Irish Republic

Tel: 1800 409 011

### Italy

Tel: +39 06 7839 2939  
Fax: +39 06 7814 7709

### Japan

Tel: +81 3 5117 7110  
Fax: +81 3 5117 7115

### Korea

Tel: +82 2 6205 6900  
Fax: +82 2 6309 6901

### Northern Ireland

Tel: 0800 132 189

### Russia

Tel and Fax: +7 495 782 21 50

### Spain

Tel: +34 902 013 346  
Fax: +34 902 013 379

### Sweden

Tel: +46 8 564 76 680  
Fax: +46 8 36 63 10

### Switzerland

Tel: 0800 83 47 63  
Fax: 0800 83 47 54

### Taiwan

Tel: +886 2 8751 1739  
Fax: +886 2 8751 5625

### Turkey

Fisher Paykel Sağlık Ürünleri  
Ticaret Limited Şirketi,  
Alinteri Bulvarı 1161/1 Sokak  
No. 12-14, P.O. Box 06371 Ostim,  
Ankara, Turkey

Tel: +90 312 354 34 12  
Fax: +90 312 354 31 01

### UK

Fisher & Paykel Healthcare Ltd  
Unit 16, Cordwallis Park  
Clivemont Road, Maidenhead  
Berkshire SL6 7BU, UK

Tel: +44 1628 626 136  
Fax: +44 1628 626 146

### USA/Canada

Tel: +1 800 446 3908  
or +1 949 453 4000  
Fax: +1 949 453 4001

CE 0123